

4x4 MiMo Omnidirectional Wall / Mast Antenna

WMM4-7-49-[VAR]

PANORAMA ANTENNAS



- 4x4 MiMo 4G/5G - 698-960/1710-4900MHz
- Wall or mast mount
- Integrated ultra-low loss cables

The WMM4-7-49 antenna provides 4x4 MiMo solution for global 4G/5G networks from 698-960/1710-4900MHz. Incorporating four separately fed, ultra wideband elements within a rugged IP65 rated compact housing, the WMM4-7-49 is suitable for a wide range of 4G Cat 18/20 and 5G fixed site and failover applications.

The supplied mounting bracket enables simple wall mounting or mast mounting using the supplied clamp. The omni-directional radiation pattern allows easy placement of the antenna without requiring any directional alignment.

The antenna has integrated ultra-low loss, double shielded CS29 cable which eliminates exposed connection points and simplifies cable management for quick and easy installation. Various connector types and configurations are available to suit different installation requirements and user device.

Technical Drawing

WMM4-7-49-5SP Shown

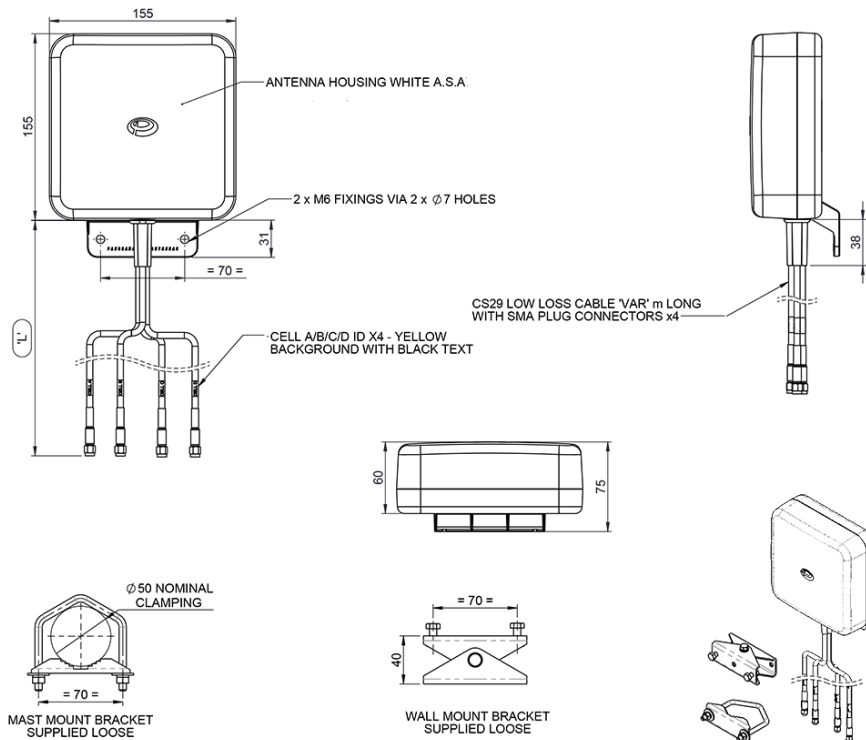

4x4 MiMo Omnidirectional Wall / Mast Antenna

WMM4-7-49-[VAR]

PANORAMA  ANTENNAS

Product Data

Part No.		WMM4-7-49-05NJ	WMM4-7-49-5SP	WMM4-7-49-5FKDJ	WMM4-7-49-10SP
Electrical Data					
Frequency Range (MHz)		698-960 / 1710-4900			
Operational Band		2G/3G/4G/5G			
Typical VSWR*		<3:1			
Polarisation		+/-45 degrees			
Pattern		Omnidirectional			
Impedance		50Ω			
Max Input Power (W)		10			
Mechanical Data					
Dimensions (mm)	Length	155 (6.1")			
	Height Excl Brkt	155 (6.1")			
	Depth	75 (2.95")			
Operating Temp (°C)		-40° / +80°C (-40° / 176°F)			
Radome Material		ASA			
Material Approvals		Radome ASA Material - UL 746C F1, UL 94-HB			
Colour		White			
Ingress Protection		IP65			
Mounting Data					
Fixing		Wall / Mast Mount			
Max Mast / Rail Diameter (mm)		20-50mm / (0.78 - 1.96")			
Cable Data					
4G/5G Cables	Type	CS29 (double shielded cable)			
	Diameter (mm)	5 (0.19")			
	Length (m)	0.5 (20")	5 (16' 4")	5 (16' 4")	10 (32')
	Termination	N Socket (f)	SMA Plug (m)	FAKRA D Jack	SMA Plug (m)

* Typical VSWR and isolation stated as measured with 0.5m (1.5') of cable in free space

4x4 MiMo Omnidirectional Wall / Mast Antenna

WMM4-7-49-[VAR]

Electrical Data

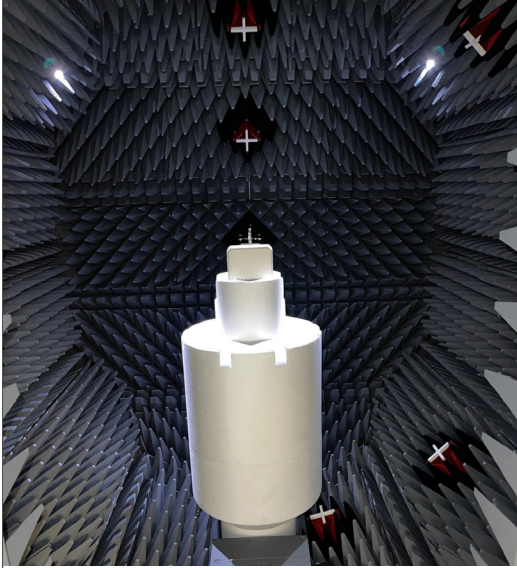
Measurement Conditions	4G/5G Antennas				
WMM4-7-49-05NJ measured in free space with 0.5m (20") CS29 pigtails	Frequency Range (MHz)	LTE Bands	Antenna Element	Peak Gain (dBi)	Efficiency (%)
	699-798	12,13,14,17,28	Cell A	0.7	45
			Cell B	1.4	35
			Cell C	2.6	57
			Cell D	0.3	39
	807- 862	5,19,20,26,27	Cell A	2.9	48
			Cell B	3.1	44
			Cell C	4.3	64
			Cell D	2.2	48
	880-960	8	Cell A	3.1	60
			Cell B	5.9	57
			Cell C	7.0	64
			Cell D	2.8	58
	1427-1518	11,21,74,75,76	Cell A	3.8	48
			Cell B	5.2	49
			Cell C	2.4	40
			Cell D	0.8	34
1710-1920	2,3,4,9,25,35,39,66	Cell A	4.2	63	
		Cell B	3.9	64	
		Cell C	3.8	55	
		Cell D	2.9	60	
1920-2170	1,23	Cell A	4.8	73	
		Cell B	6.9	74	
		Cell C	6.5	71	
		Cell D	3.2	71	
2300-2400	30,40	Cell A	4.6	76	
		Cell B	6.4	78	
		Cell C	4.1	76	
		Cell D	2.5	77	
2496-2690	7,38,41	Cell A	5.3	78	
		Cell B	5.1	80	
		Cell C	4.4	79	
		Cell D	4.1	76	
3300-4200	22,42,43,48,77,78,79	Cell A	6.6	75	
		Cell B	5.0	76	
		Cell C	5.2	76	
		Cell D	6.8	77	
4400-5000	79	Cell A	6.7	72	
		Cell B	7.0	69	
		Cell C	7.2	65	
		Cell D	7.7	70	

4x4 MiMo Omnidirectional Wall / Mast Antenna

WMM4-7-49-[VAR]

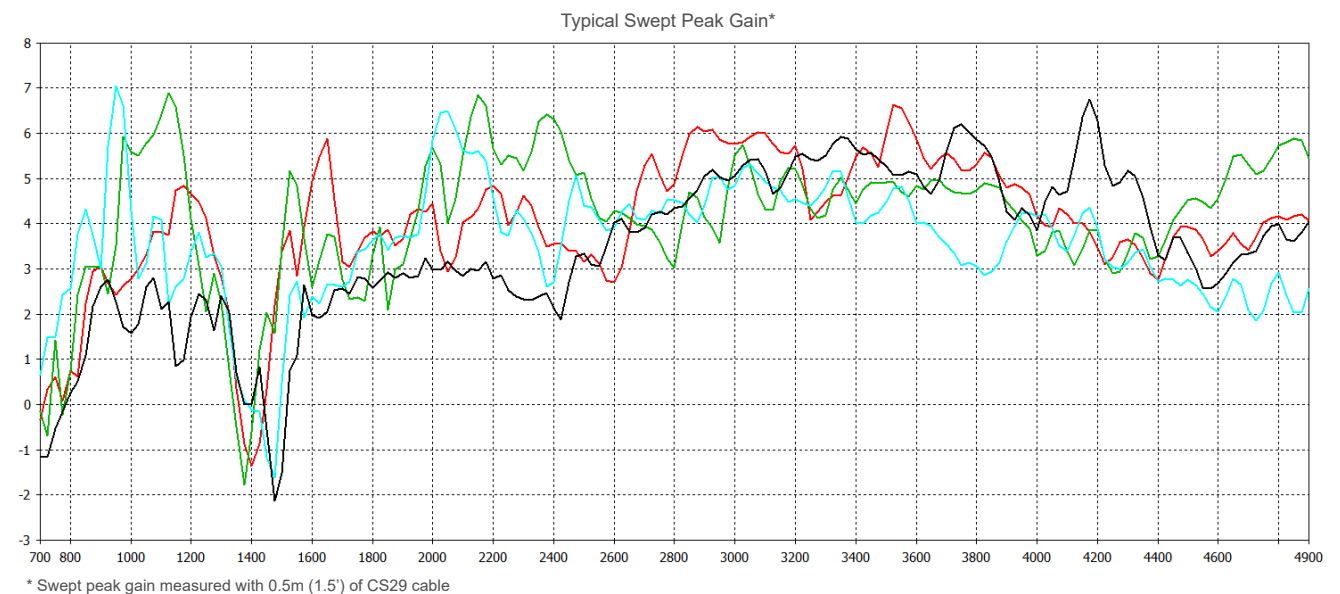
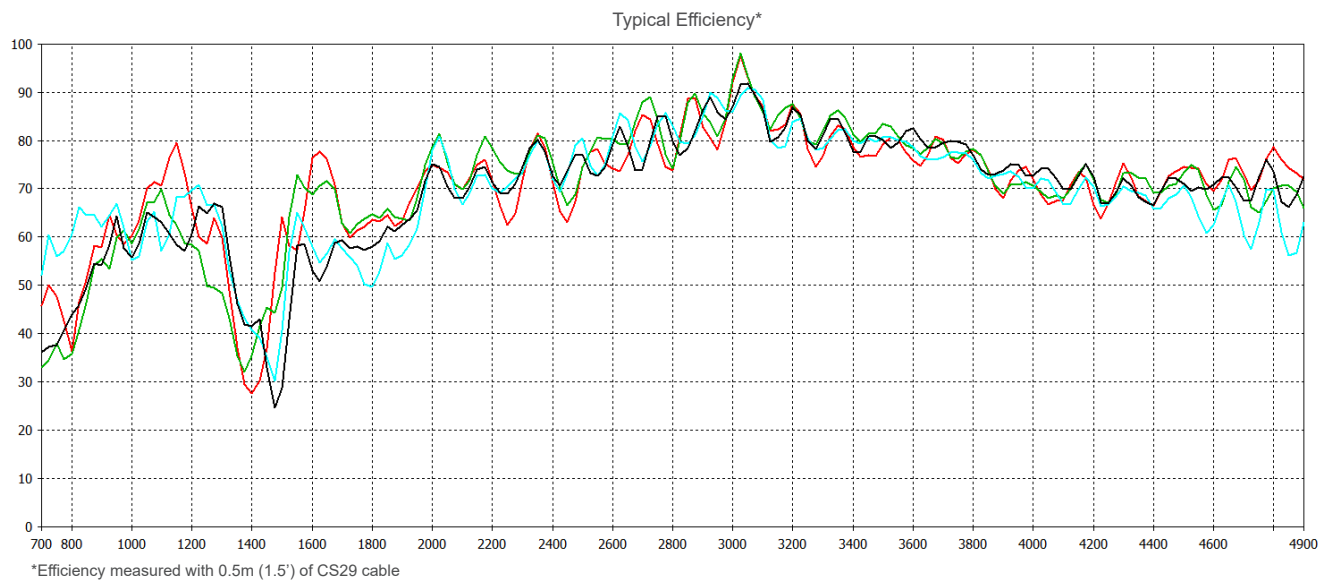
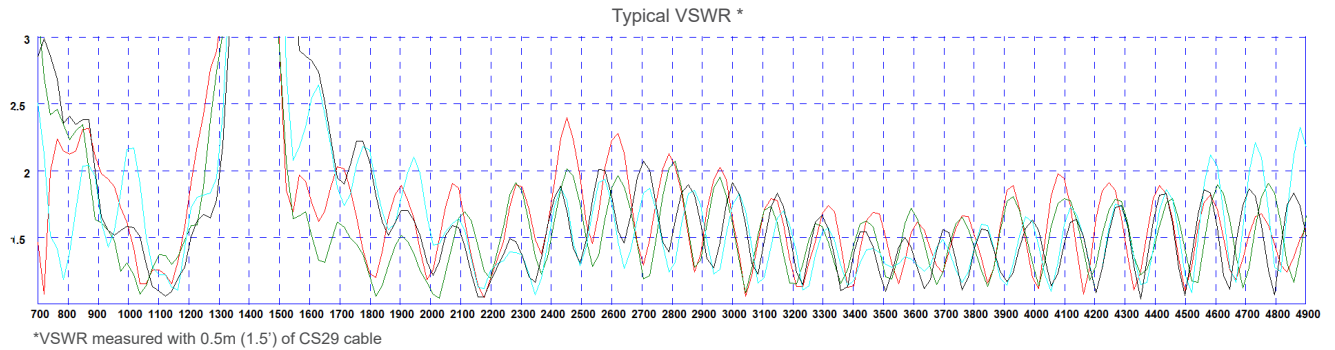

4x4 MiMo Omnidirectional Wall / Mast Antenna

WMM4-7-49-[VAR]

3D Patterns -Cell A

Typical 3D Pattern- Cell A - 750 MHz

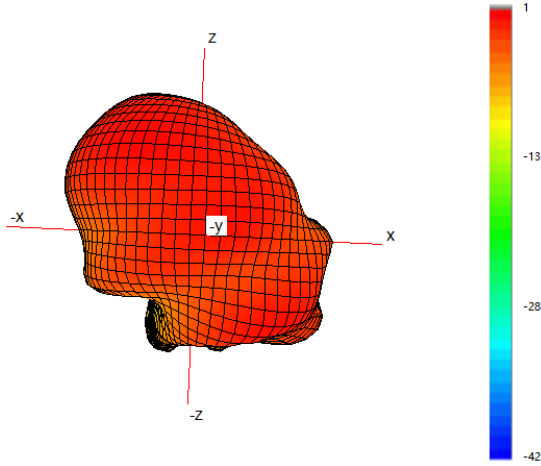

Typical H Plane- Cell A - Patterns- 700-800MHz

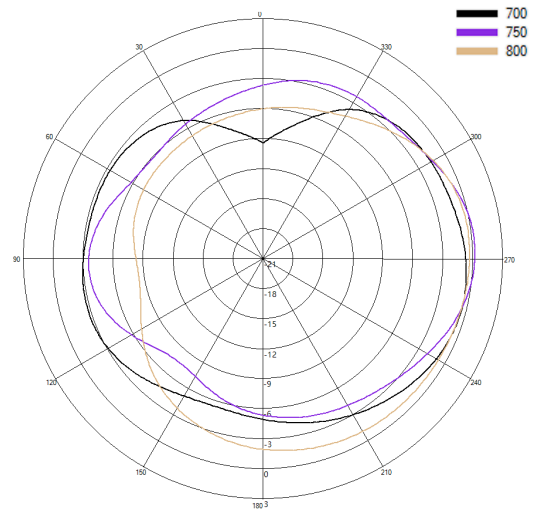

Typical 3D Pattern- Cell A - 850 MHz

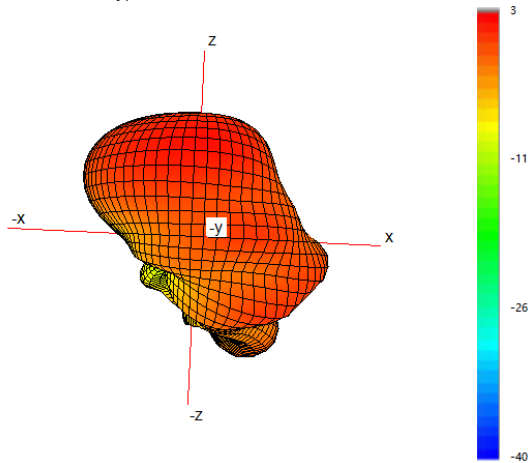

Typical H Plane- Cell A - Patterns- 800-900MHz

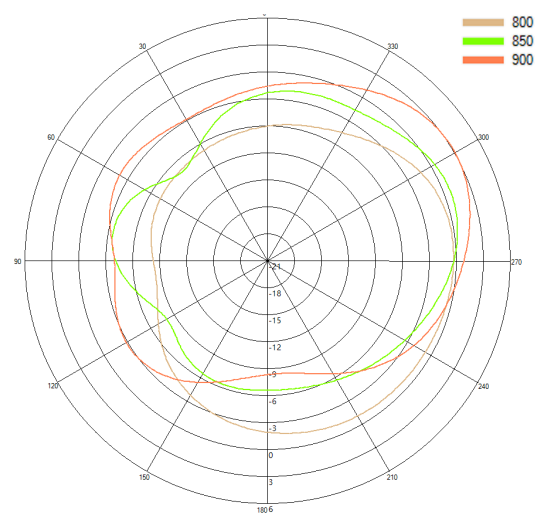

Typical 3D Pattern- Cell A - 1475 MHz

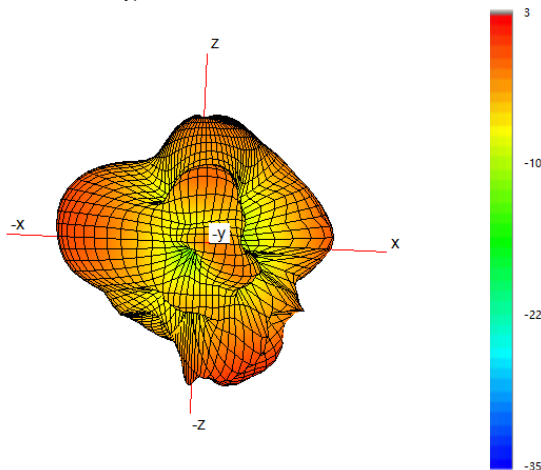

Typical H Plane- Cell A - Patterns- 1450-1500 MHz

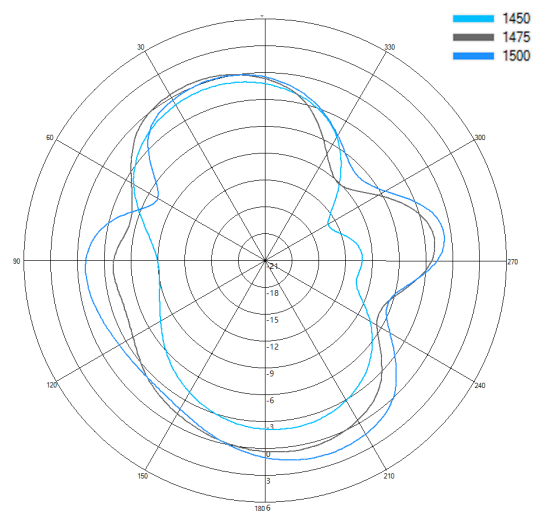

4x4 MiMo Omnidirectional Wall / Mast Antenna

WMM4-7-49-[VAR]

3D Patterns Cell A

Typical 3D Pattern- Cell A - 1800 MHz

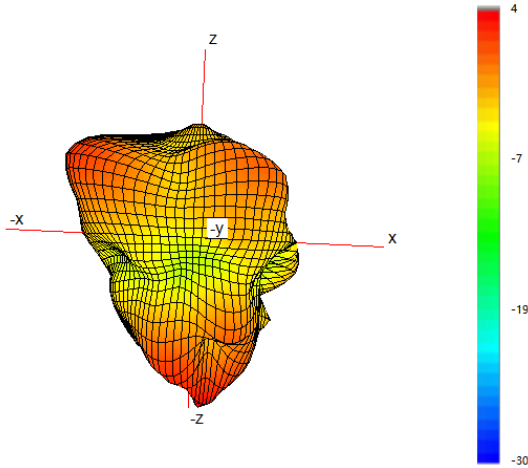

Typical H Plane- Cell A- Patterns- 1750-1850 MHz

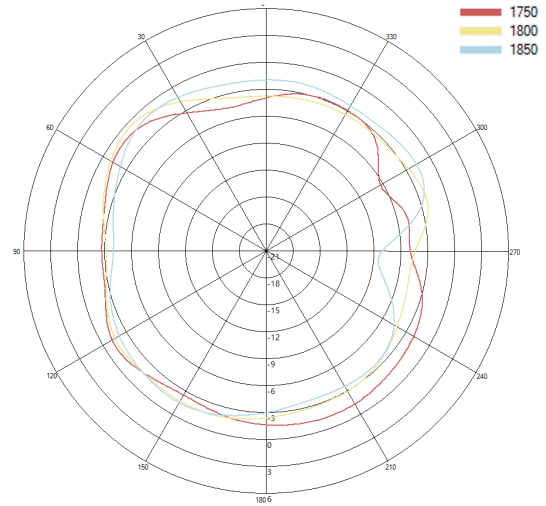

Typical 3D Pattern- Cell A - 2150 MHz

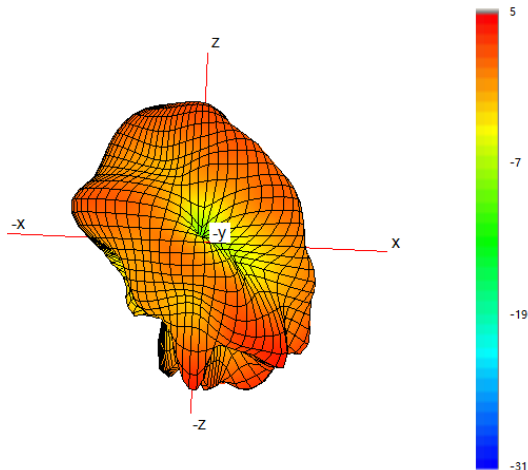

Typical H Plane- Cell A- Patterns- 2100-2200 MHz

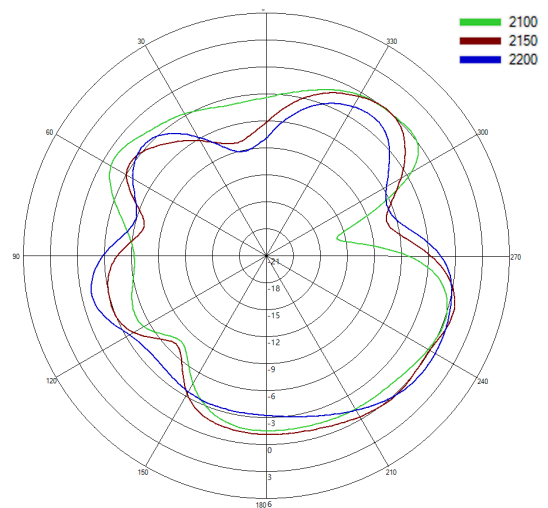

Typical 3D Pattern- Cell A - 2350 MHz

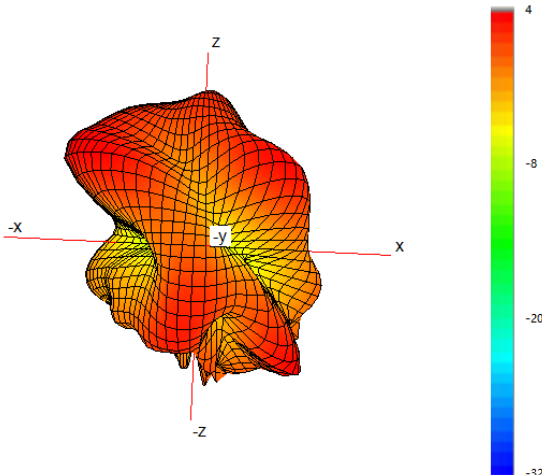

Typical H Plane- Cell A - Patterns- 2300-2400 MHz

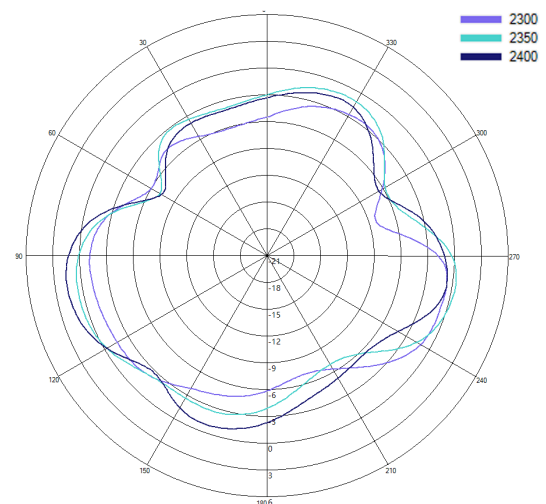

4x4 MiMo Omnidirectional Wall / Mast Antenna

WMM4-7-49-[VAR]

3D Patterns - Cell A

Typical 3D Pattern- Cell A - 2650 MHz

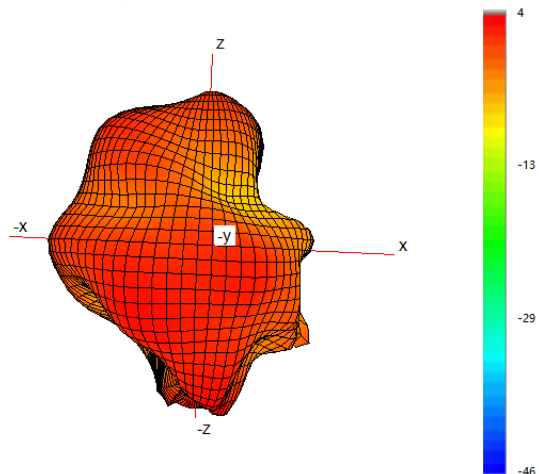

Typical H Plane- Cell A - Patterns- 2600-2700 MHz

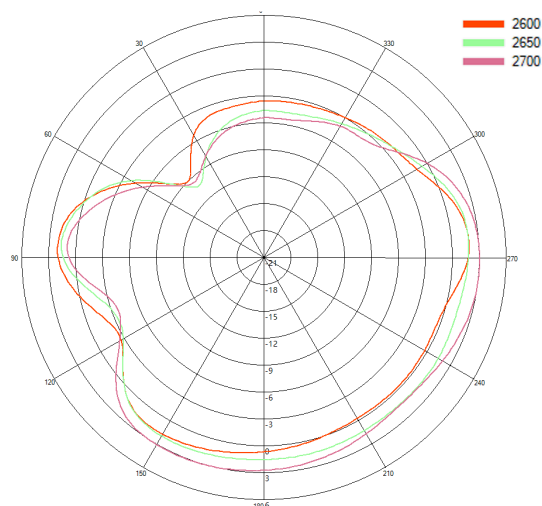

Typical 3D Pattern- Cell A - 3600 MHz

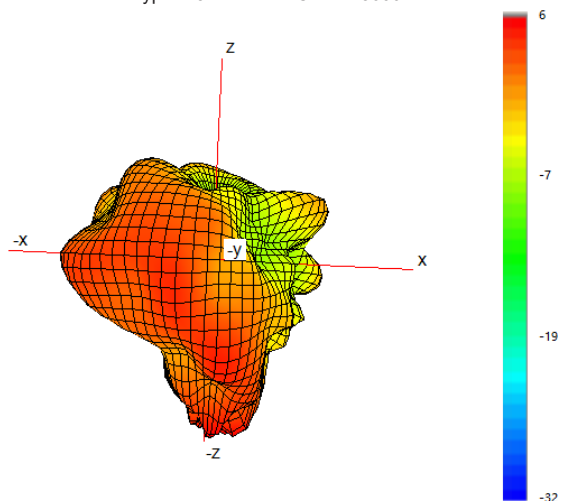

Typical H Plane- Cell A - Patterns- 3400-3800 MHz

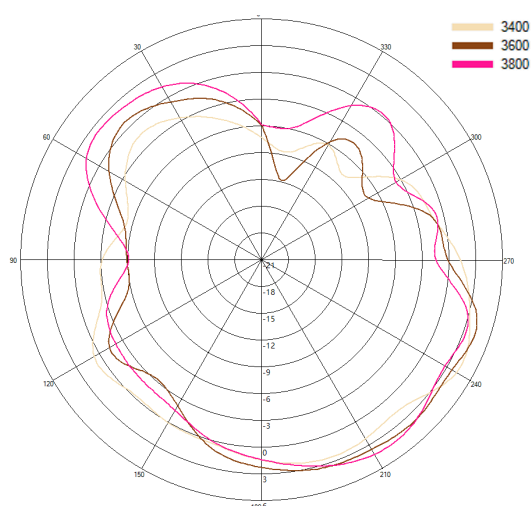

4x4 MiMo Omnidirectional Wall / Mast Antenna

WMM4-7-49-[VAR]

3D Patterns Cell B

Typical 3D Pattern- Cell B - 750 MHz

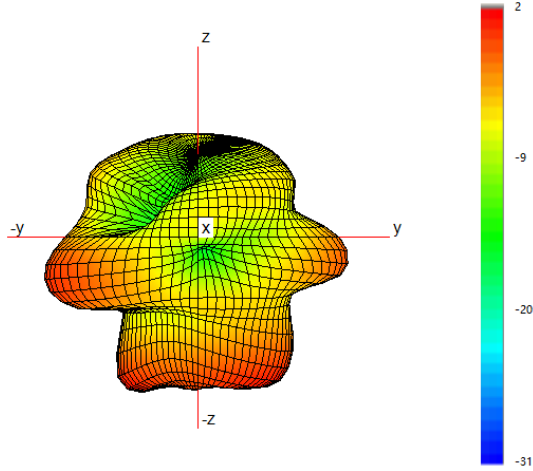

Typical H Plane- Cell B - Patterns- 700-800MHz

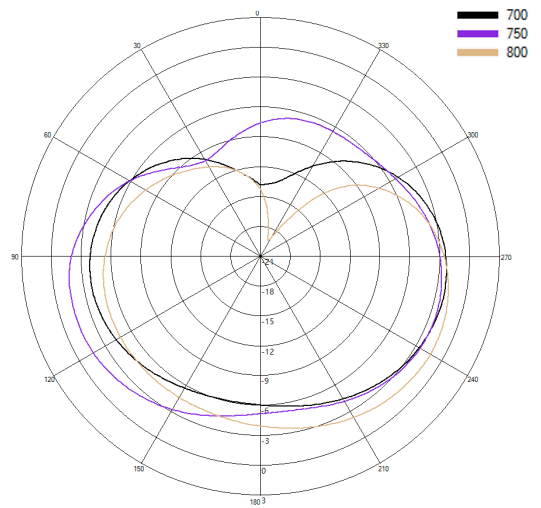

Typical 3D Pattern- Cell B - 850 MHz

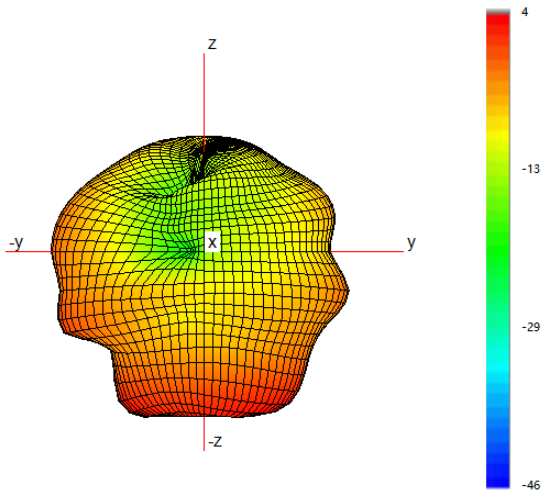

Typical H Plane- Cell B - Patterns- 800-900MHz

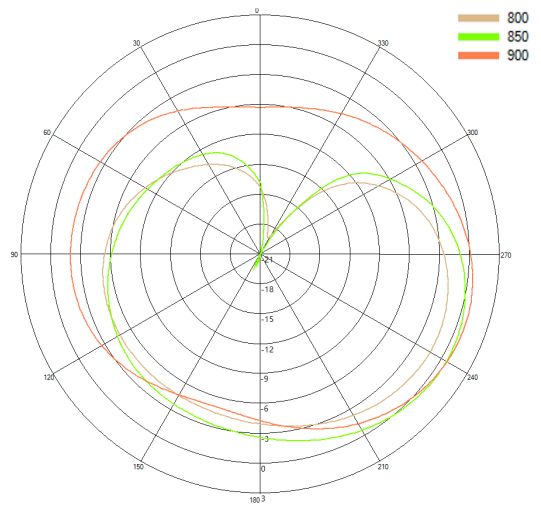

Typical 3D Pattern- Cell B - 1475 MHz

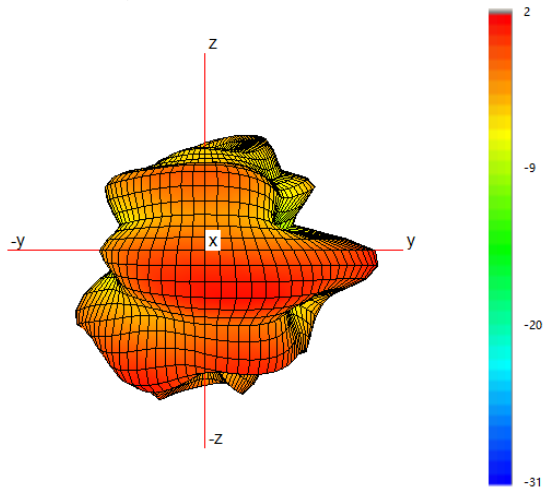

Typical H Plane- Cell B- Patterns- 1450-1500 MHz

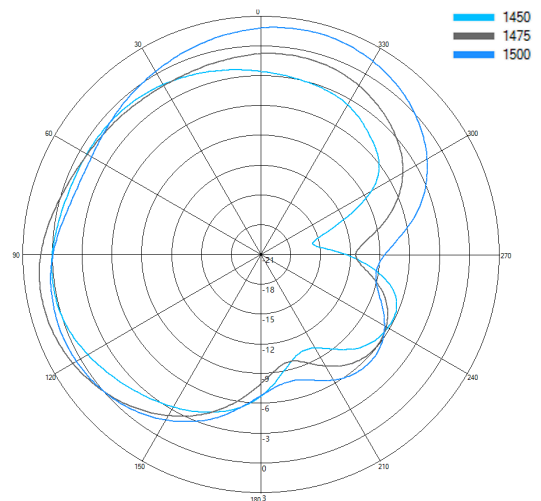

4x4 MiMo Omnidirectional Wall / Mast Antenna

WMM4-7-49-[VAR]

3D Patterns -Cell B

Typical 3D Pattern- Cell B - 1800 MHz

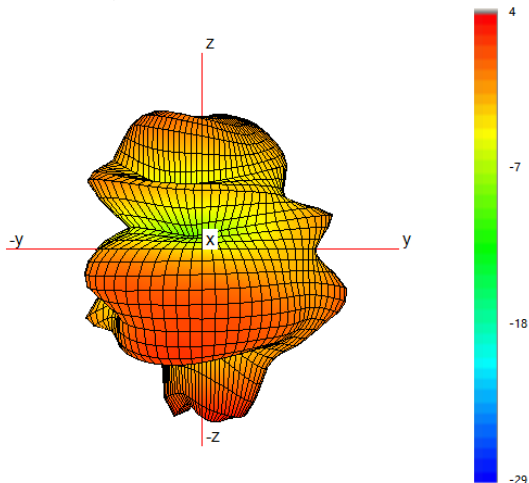

Typical H Plane- Cell B- Patterns- 1750-1850 MHz

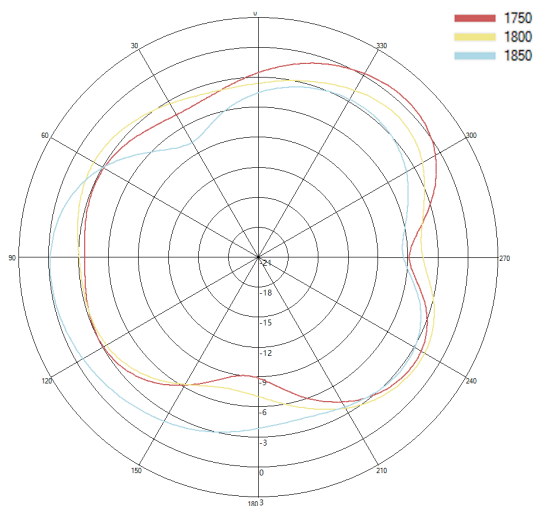

Typical 3D Pattern- Cell B - 2150 MHz

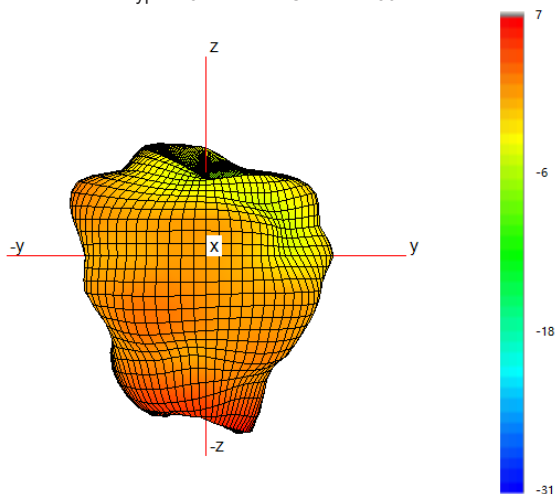

Typical H Plane- Cell B- Patterns- 2100-2200 MHz

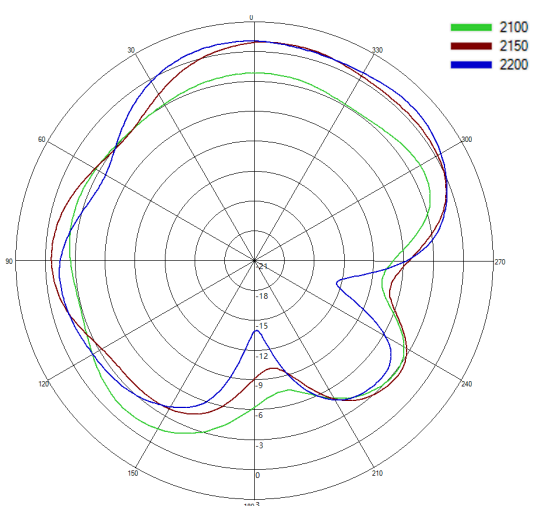

Typical 3D Pattern- Cell B - 2350 MHz

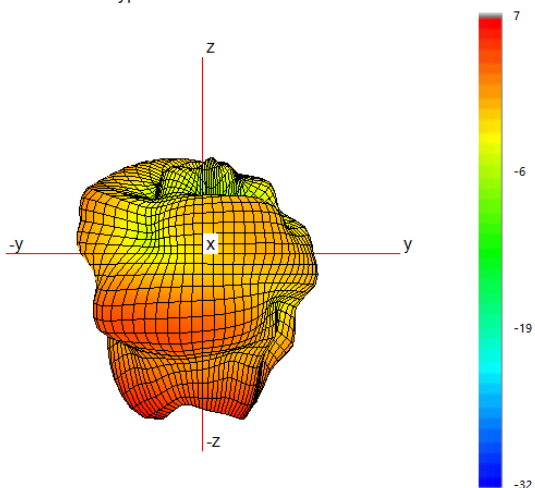

Typical H Plane- Cell B - Patterns- 2300-2400 MHz

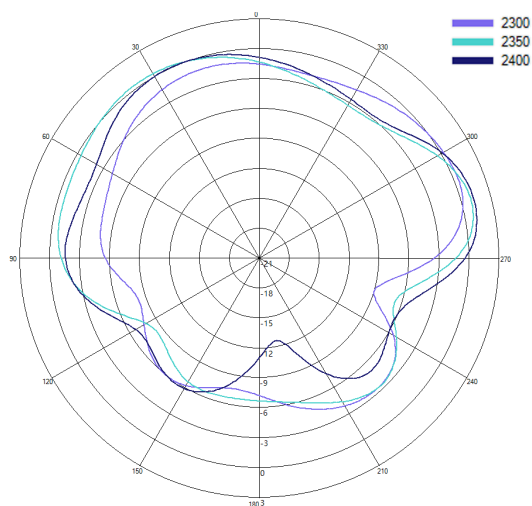

4x4 MiMo Omnidirectional Wall / Mast Antenna

WMM4-7-49-[VAR]

3D Patterns Cell B

Typical 3D Pattern- Cell B - 2650 MHz

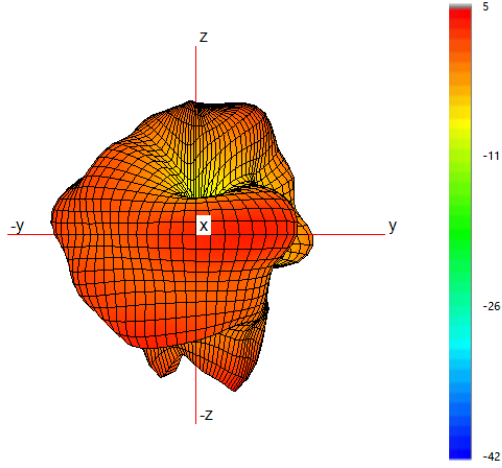

Typical H Plane- Cell B - Patterns- 2600-2700 MHz

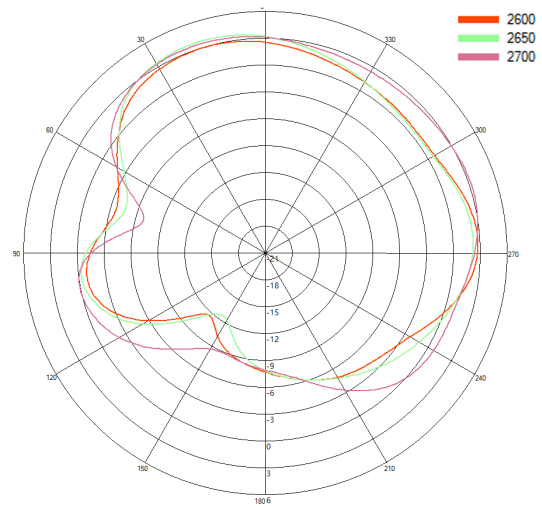

Typical 3D Pattern- Cell B - 3600 MHz

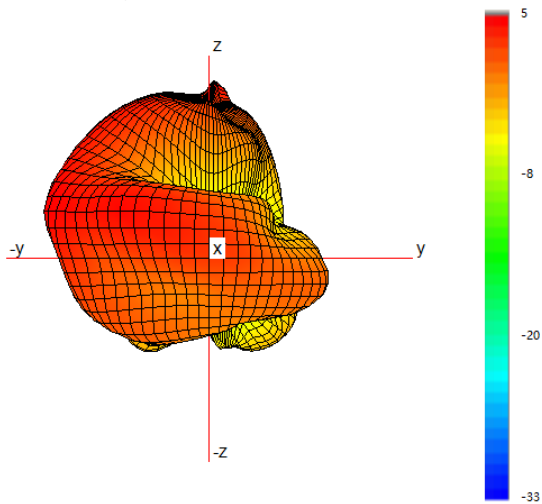

Typical H Plane- Cell B - Patterns- 3400-3800 MHz

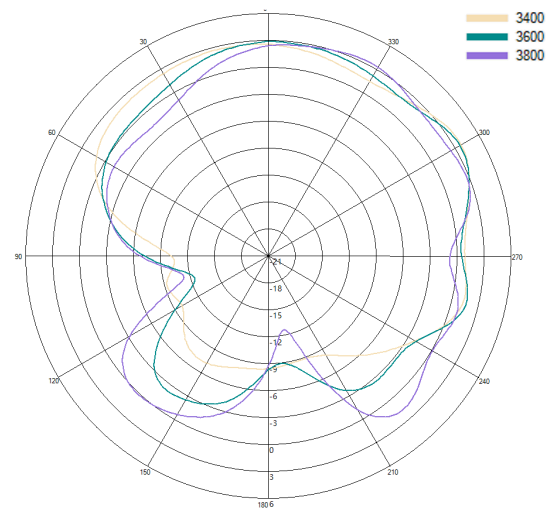

4x4 MiMo Omnidirectional Wall / Mast Antenna

WMM4-7-49-[VAR]

3D Patterns -Cell C

Typical 3D Pattern- Cell C - 750 MHz

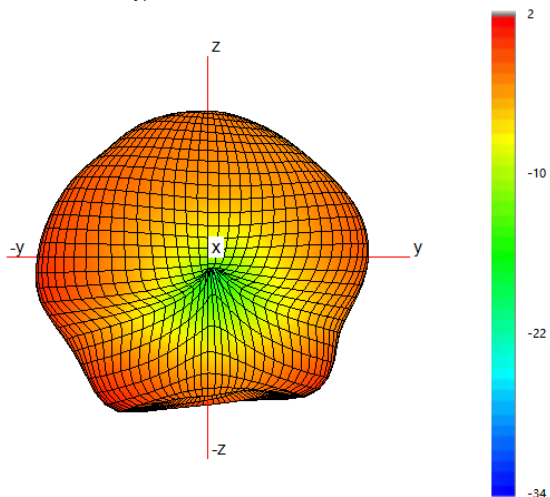

Typical H Plane- Cell C - Patterns- 700-800MHz

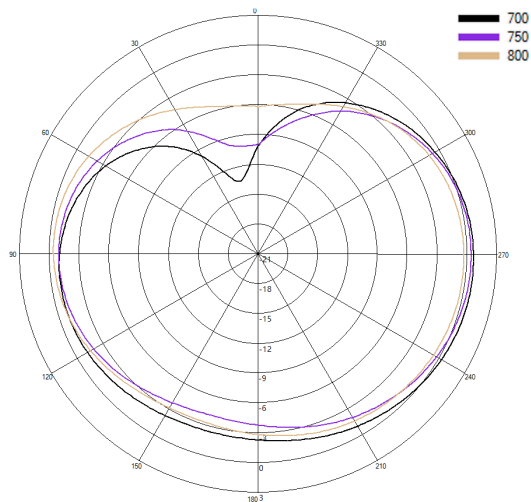

Typical 3D Pattern- Cell C - 850 MHz

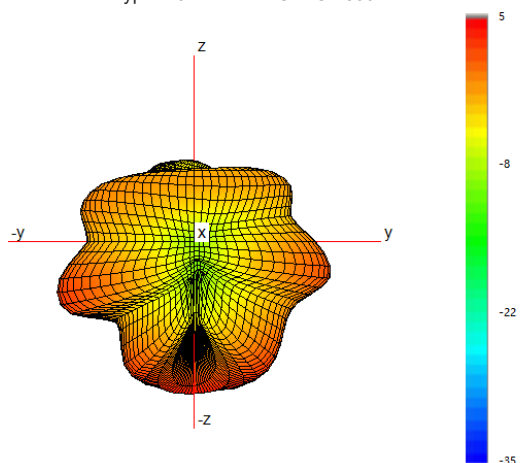

Typical H Plane- Cell C - Patterns- 800-900MHz

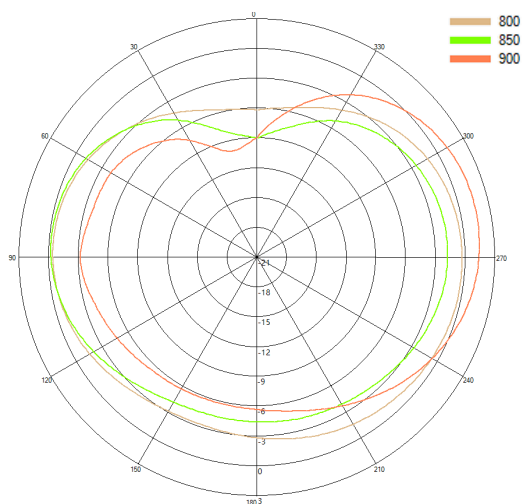

Typical 3D Pattern- Cell C - 1475 MHz

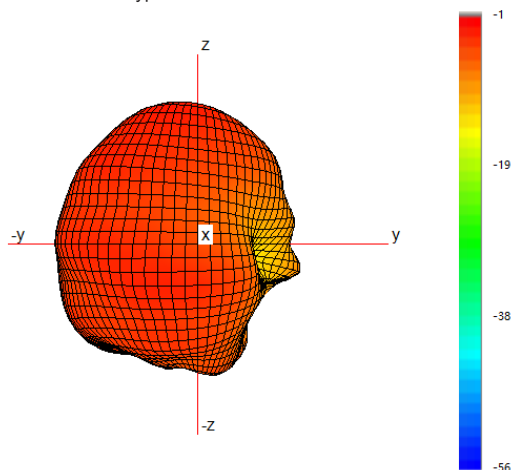

Typical H Plane- Cell C- Patterns- 1450-1500 MHz

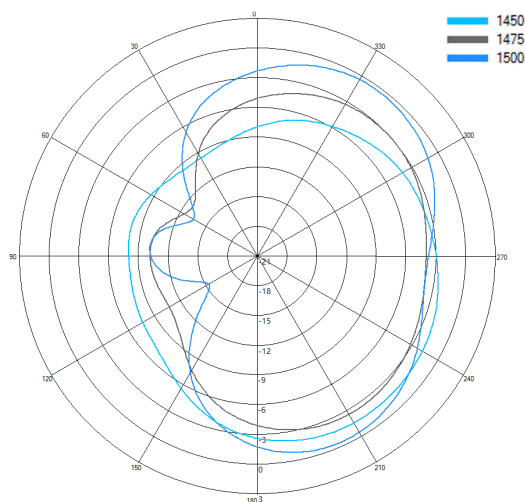

4x4 MiMo Omnidirectional Wall / Mast Antenna

WMM4-7-49-[VAR]

3D Patterns Cell C

Typical 3D Pattern- Cell C - 1800 MHz

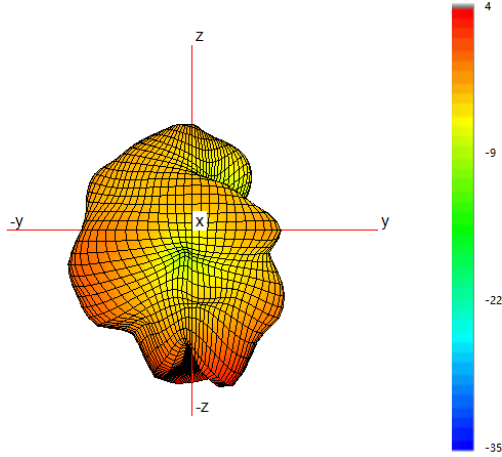

Typical H Plane- Cell C- Patterns- 1750-1850 MHz

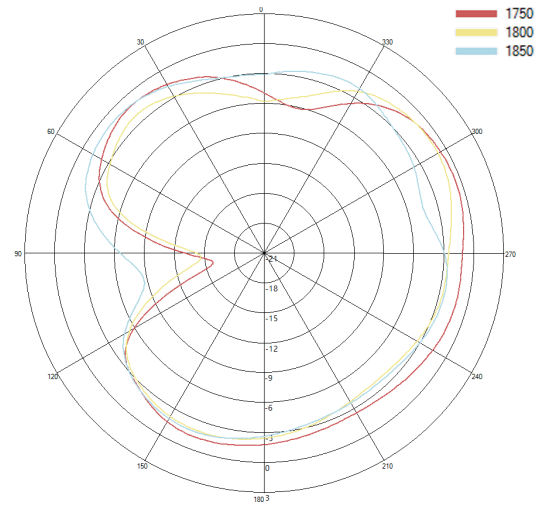

Typical 3D Pattern- Cell C - 2150 MHz

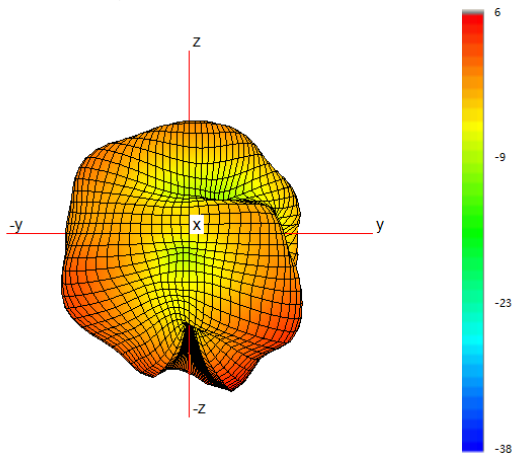

Typical H Plane- Cell C- Patterns- 2100-2200 MHz

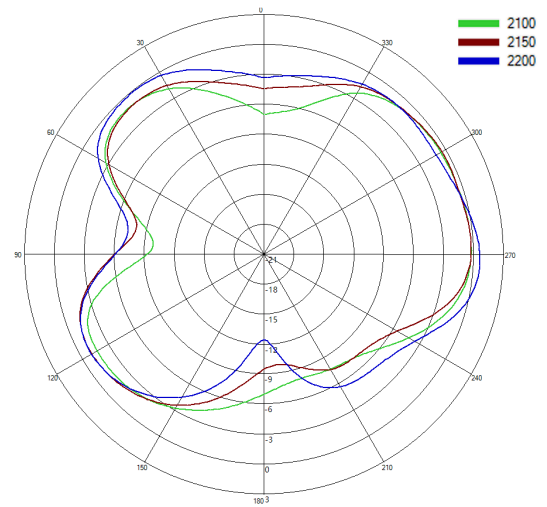

Typical 3D Pattern- Cell C - 2350 MHz

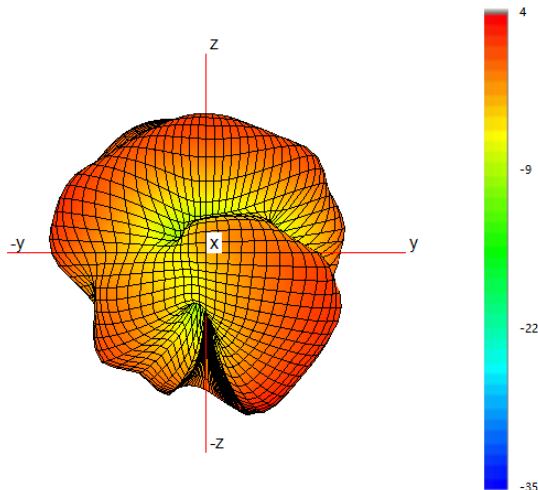

Typical H Plane- Cell C - Patterns- 2300-2400 MHz

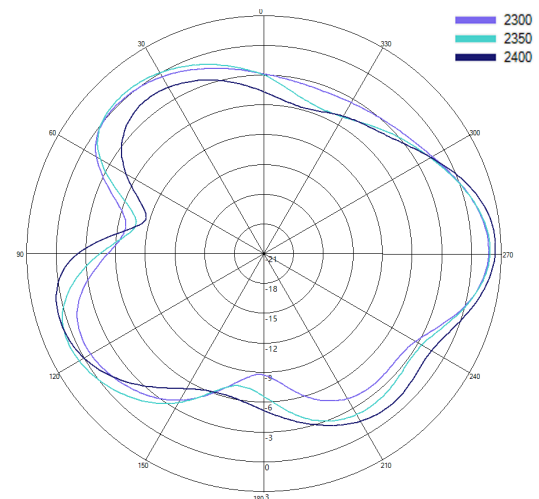

4x4 MiMo Omnidirectional Wall / Mast Antenna

WMM4-7-49-[VAR]

3D Patterns - Cell C

Typical 3D Pattern- Cell C - 2650 MHz

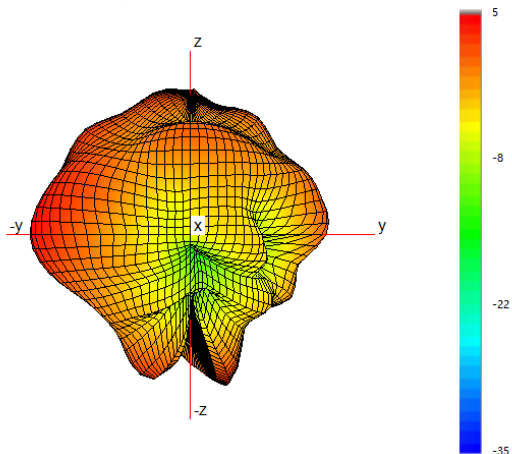

Typical H Plane- Cell C - Patterns- 2600-2700 MHz

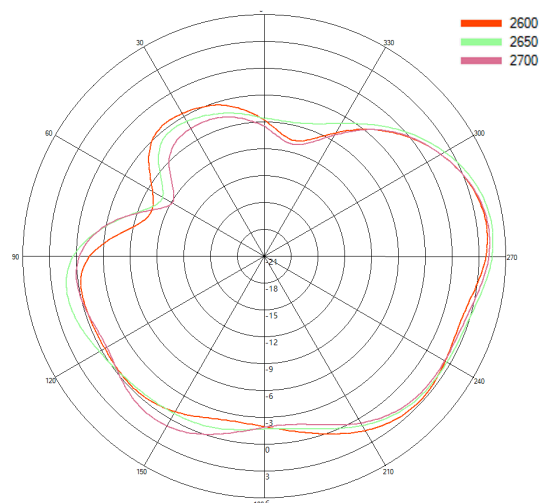

Typical 3D Pattern- Cell C - 3600 MHz

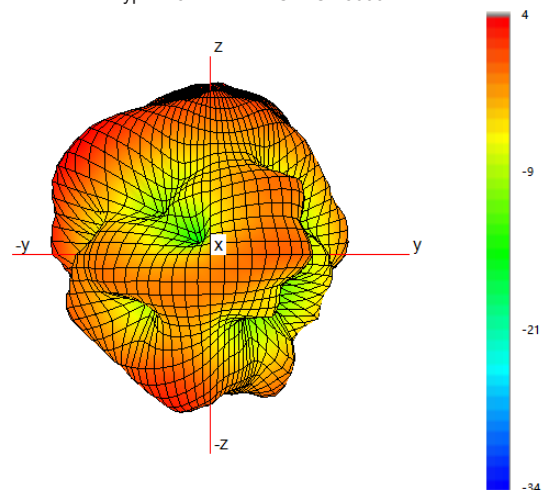

Typical H Plane- Cell C - Patterns- 3400-3800 MHz

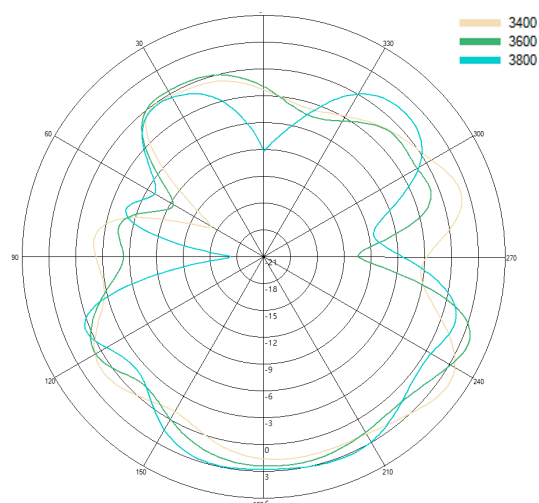

4x4 MiMo Omnidirectional Wall / Mast Antenna

WMM4-7-49-[VAR]

3D Patterns Cell D

Typical 3D Pattern- Cell D - 750 MHz

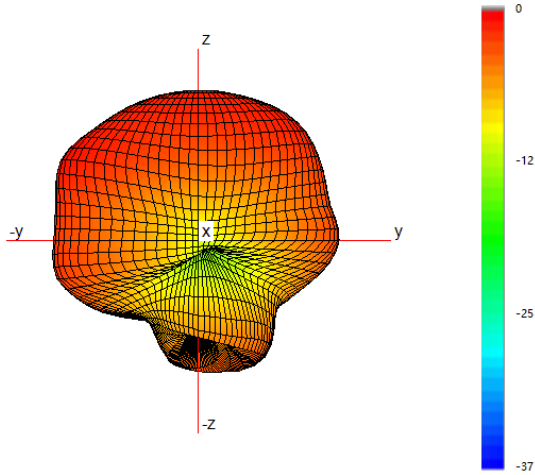

Typical H Plane- Cell D - Patterns- 700-800MHz

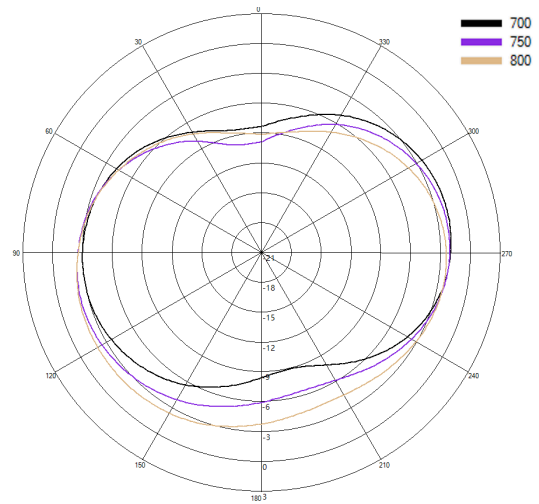

Typical 3D Pattern- Cell D - 850 MHz

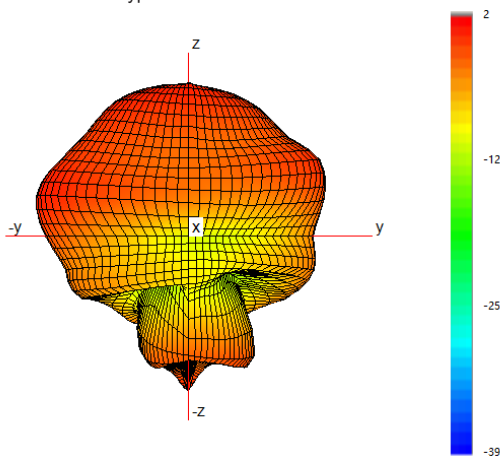

Typical H Plane- Cell D - Patterns- 800-900MHz

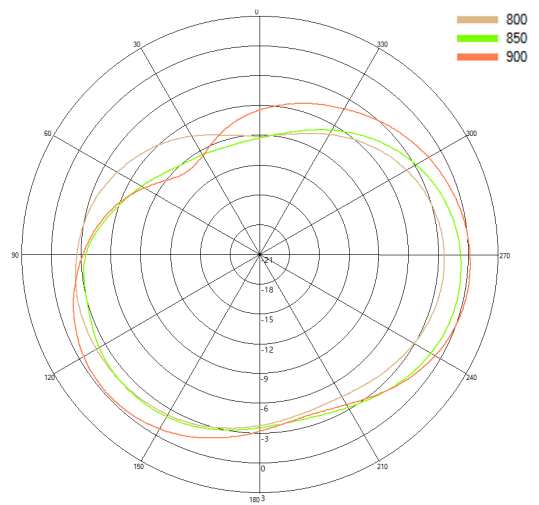

Typical 3D Pattern- Cell D - 1475 MHz

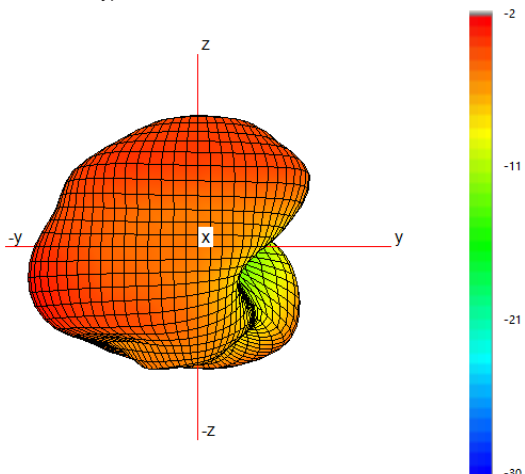

Typical H Plane- Cell D- Patterns- 1450-1500 MHz

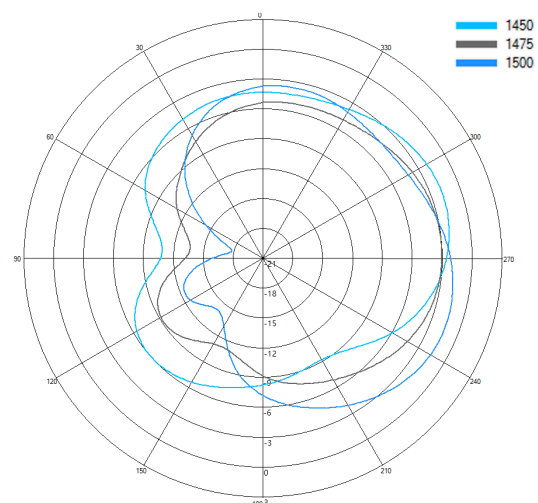

4x4 MiMo Omnidirectional Wall / Mast Antenna

WMM4-7-49-[VAR]

3D Patterns - Cell D

Typical 3D Pattern- Cell D - 1800 MHz

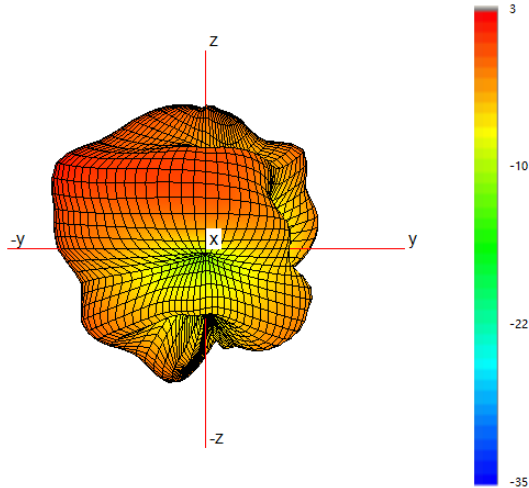

Typical H Plane- Cell D- Patterns- 1750-1850 MHz

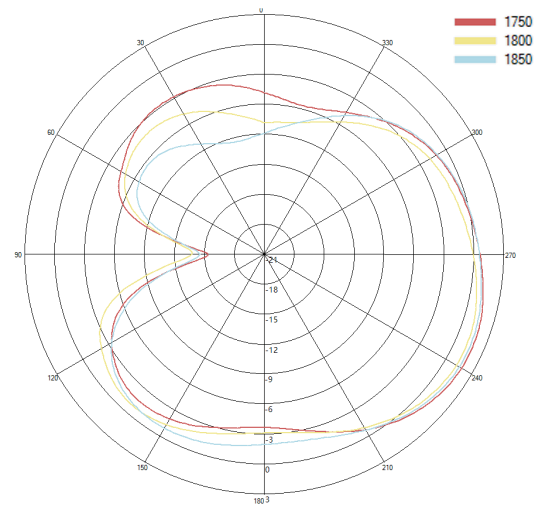

Typical 3D Pattern- Cell D - 2150 MHz

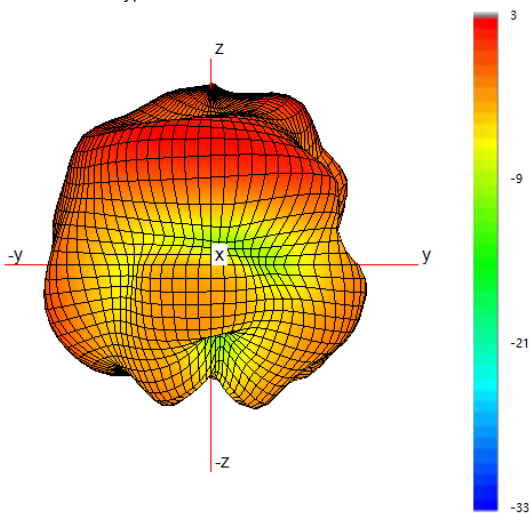

Typical H Plane- Cell D- Patterns- 2100-2200 MHz

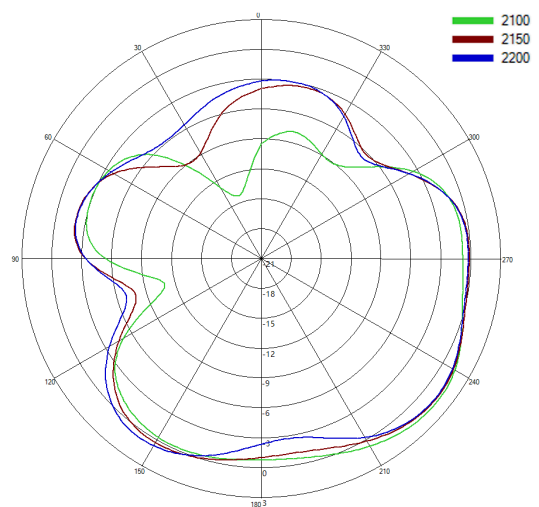

Typical 3D Pattern- Cell D - 2350 MHz

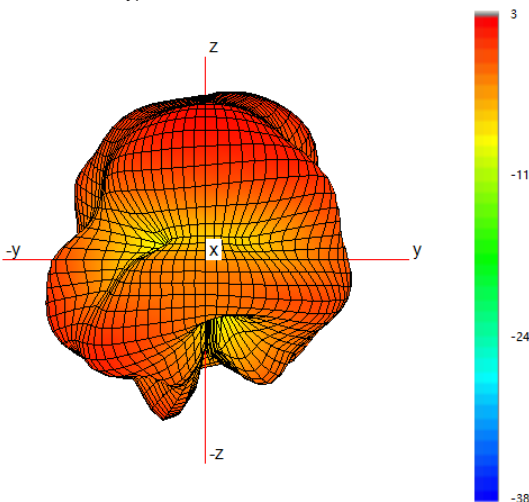

Typical H Plane- Cell D - Patterns- 2300-2400 MHz

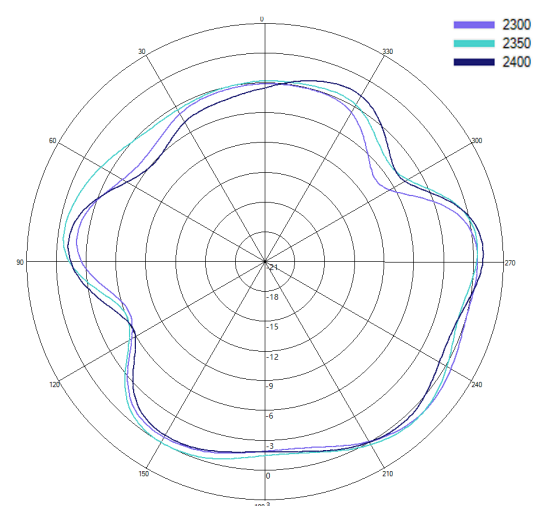

4x4 MiMo Omnidirectional Wall / Mast Antenna

WMM4-7-49-[VAR]

3D Patterns Cell D

Typical 3D Pattern- Cell D - 2650 MHz

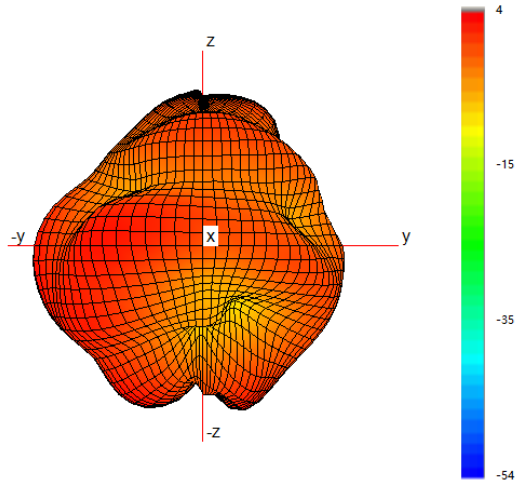

Typical H Plane- Cell D - Patterns- 2600-2700 MHz

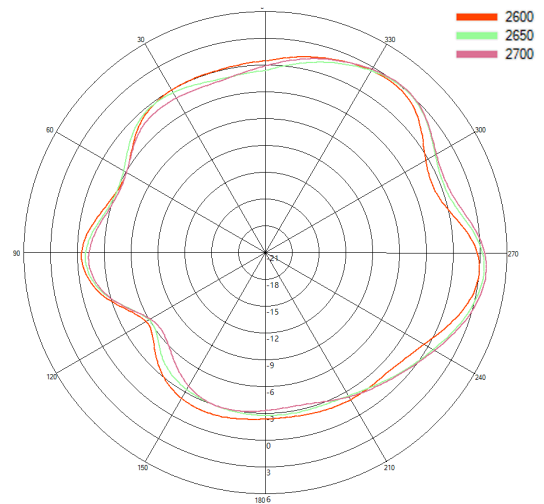

Typical 3D Pattern- Cell D - 3600 MHz

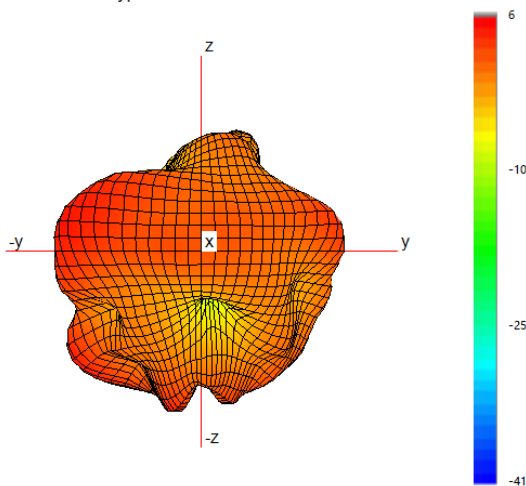

Typical H Plane- Cell D - Patterns- 3400-3800 MHz

